



**USER'S MANUAL**  
*MANUEL DE L'UTILISATEUR*  
*MANUAL DEL USUARIO*

**TX-42F970Z**



[www.wde.com](http://www.wde.com)

# TABLE OF CONTENT

DIGITAL TELEVISION TRANSITION NOTICE .....	1
FOR YOUR SAFETY .....	2
PRECAUTIONS AND REMINDERS .....	3
IMPORTANT SAFETY INSTRUCTIONS .....	4
PACKAGE CONTENTS.....	5
PREPARATION.....	6
ATTACHING THE BASE.....	6
PREPARING YOUR LCD HDTV FOR WALL MOUNTING .....	6
PERIPHERAL CONNECTION GUIDE .....	8
OPERATING INSTRUCTIONS.....	9
TO USE THE FRONT PANEL CONTROL.....	9
TO USE THE REMOTE CONTROL.....	10
TO USE THE MENUS .....	11
CHANNEL MENU .....	11
VIDEO MENU .....	11
AUDIO MENU .....	12
FEATURE MENU.....	12
VGA MENU.....	14
TIPS.....	15
PRODUCT SPECIFICATION.....	16
BEFORE CALLING SERVICE .....	17
GLOSSARY .....	18

# DIGITAL TELEVISION TRANSITION NOTICE

This device contains a digital television tuner, so it should receive digital over the air TV programming, with a suitable antenna, after the end of full-power analog TV broadcasting in the United States on June 12 2009. Some older television receivers, if they rely on a TV antenna, will need a TV Converter to receive over the air digital programming, but should continue to work as before for other purposes (e.g., for watching low-power TV stations still broadcasting in analog, watching pre-recorded movies, or playing video games).

For more information, call the FCC at 1-888-CALL-FCC (1-888-225-5322) or see [www.DTV.gov](http://www.DTV.gov).



For information on the TV Converter program, and on government coupons that may be used toward the purchase of one, see [www.dtv2009.gov](http://www.dtv2009.gov), or call the NTIA at 1-888-DTV-2009.

## AVISO RELATIVO A LA TRANSICIÓN A TELEVISIÓN DIGITAL

Este equipo incorpora un sintonizador de televisión digital, lo que le permitirá recibir una programación digital televisada por aire, con una antena adecuada, cuando se terminará la transmisión de alta potencia de la televisión analógica en los Estados Unidos el 12 de Junio de 2009. Ciertos receptores de televisión antiguos, si dependen de una antena de TV, necesitarán un conversor de TV para recibir por el aire una programación digital, pero seguirán funcionando como antes para otros usos (por ejemplo para ver emisoras de TV de baja potencia que todavía transmiten en analógico, para ver películas pregrabadas, o para utilizar sus videojuegos).

Para obtener más información, llame FCC 1-888-CALL-FCC (1-888-225-5322) o refiérase a [www.DTV.gov](http://www.DTV.gov).

Para toda información sobre el programa de conversores de TV, y acerca de los cupones del gobierno que se pueden usar para comprarlos, refiérase a [www.dtv2009.gov](http://www.dtv2009.gov), o llame al NTIA al 1-888-DTV-2009

SYMBOL	SYMBOL DEFINITION
 SA 1965	<p><b>DANGEROUS VOLTAGE:</b> The lightning flash with arrowhead symbol, within an equilateral triangle, is intended to alert the user to the presence of uninsulated “dangerous voltage” within the product’s enclosure that may be of sufficient magnitude to constitute a risk of electrical shock to persons.</p>
 SA 1966	<p><b>INSTRUCTIONS:</b> The exclamation point within an equilateral triangle to alert the user to the presence of important operating and maintenance (servicing) instruction in the literature accompanying the appliance.</p>

Apparatus shall not be exposed to dripping or splashing and no objects filled with liquids, Such as vases, shall be placed on the apparatus.

Caution - Danger of explosion if battery is incorrectly replaced. Replace only with the same or equivalent type.

### Batteries installed warning

Caution - Danger of explosion if battery is incorrectly replaced. Replace only with the same or equivalent type.

The batteries (battery pack or batteries installed) shall not be exposed to excessive heat such as sunshine, fire or the like.

## FOR YOUR SAFETY

Before operating the TV please read this manual thoroughly. This manual should be retained for future reference.

### FCC Class B Radio Frequency Interference Statement

#### **WARNING: (FOR FCC CERTIFIED MODELS)**

**NOTE:** This equipment has been tested and found to comply with the limits for a Class B digital device, pursuant to Part 15 of the FCC Rules. These limits are designed to provide reasonable protection against harmful interference in a residential installation. This equipment generates, uses and can radiate radio frequency energy, and if not installed and used in accordance with the instructions, may cause harmful interference to radio communications. However, there is no guarantee that interference will not occur in a particular installation. If this equipment does cause harmful interference to radio or television reception, which can be determined by turning the equipment off and on, the user is encouraged to try to correct the interference by one or more of the following measures:

1. Reorient or relocate the receiving antenna.
2. Increase the separation between the equipment and receiver.
3. Connect the equipment into an outlet on a circuit different from that to which the receiver is connected.
4. Consult the dealer or an experienced radio/TV technician for help.

#### **NOTICE**

1. The changes or modifications not expressly approved by the party responsible for compliance could void the user's authority to operate the equipment.
2. Shielded interface cables and AC power cord, if any, must be used in order to comply with the emission limits.
3. The manufacturer is not responsible for any radio or TV interference caused by unauthorized modification to this equipment. It is the responsibilities of the user to correct such interference.

#### **WARNING:**

To prevent fire or shock hazard, do not expose the TV to rain or moisture. Dangerously high voltages are present inside the TV. Do not open the cabinet. Refer servicing to qualified personnel only.

#### **SAFETY: Lamp Disposal**

(Hg) LAMP(S) INSIDE THIS PRODUCT CONTAIN MERCURY AND MUST BE RECYCLED OR DISPOSED OF ACCORDING TO LOCAL, STATE OR FEDERAL LAWS. FOR MORE INFORMATION, CONTACT THE ELECTRONIC INDUSTRIES ALLIANCE AT [WWW.EIAE.ORG](http://WWW.EIAE.ORG).

# PRECAUTIONS AND REMINDERS

Place unit on even surfaces.

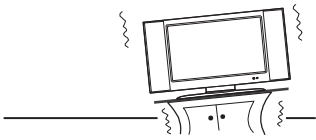

Unplug immediately if other foreign materials are put inside TV box or if the TV fell down.

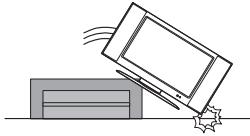

Do not cover or block any vents and openings. Inadequate ventilation may shorten the life of the display unit and cause overheating.

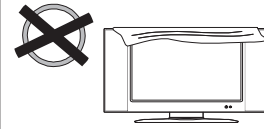

Unplug immediately if malfunction like no picture, no video/audio, smoke and bad odor from TV.



Prohibit/Avoid opening TV cabinet.

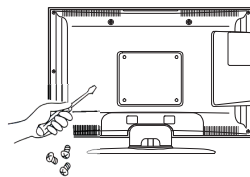

Avoid direct sunlight, dusty, high humidity and smoky areas.

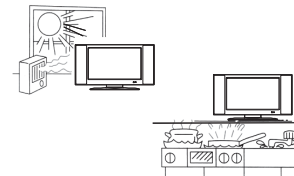

Don't throw any object inside the TV box like metals or other flammable materials.

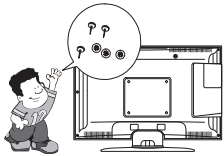

Remember to unplug the AC cord from the AC outlet before cleaning. Do not use liquid cleaners or aerosol cleaners to clean the display.



Call service personnel to clean the internal part of the TV once a year.



Don't place the TV in confined spaces or in a box when using it.

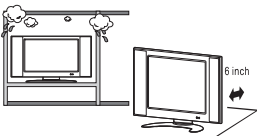

Make sure to unplug the unit when not in use for a long period of time (days).

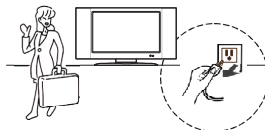

Do not place the display near water, such as bathtub, washbasin, kitchen sink laundry tub, swimming pool or in a damp basement.

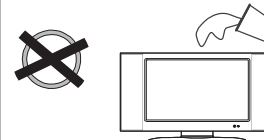

## Notice for Remote Controller

Avoid Dropping



Avoid Liquids



Avoid Aerosol Cleaners



# IMPORTANT SAFETY INSTRUCTIONS

---

## Read before operating equipment

1. Read these instructions.
2. Keep these instructions.
3. Heed all warnings.
4. Follow all instructions.
5. Do not use this apparatus near water.
6. Clean only with a dry cloth.
7. Do not block any of the ventilation openings. Install in accordance with the manufacturers instructions.
8. Do not install near any heat sources such as radiators, heat registers, stoves, or other apparatus (including amplifiers) that produce heat.
9. Do not defeat the safety purpose of the polarized or grounding type plug. A polarized plug has two blades with one wider than the other. A grounding type plug has two blades and third grounding prong. The wide blade or third prong is provided for your safety. When the provided plug does not fit into your outlet, consult an electrician for replacement of the obsolete outlet.
10. Protect the power cord from being walked on or pinched particularly at plugs, convenience receptacles, and the point where they exit from the apparatus.
11. Only use attachments/accessories specified by the manufacturer.
12. Use only with a cart, stand, tripod, bracket, or table specified by the manufacturer, or sold with the apparatus. When a cart is used, use caution when moving the cart/apparatus combination to avoid injury from tip-over.



13. Unplug this apparatus during lightning storms or when unused for long periods of time.
14. Refer all servicing to qualified service personnel. Servicing is required when the apparatus has been damaged in any way, such as power-supply cord or plug is damaged, liquid has been spilled or objects have fallen into apparatus, the apparatus has been exposed to rain or moisture, does not operate normally, or has been dropped.
15. The TV should be operated only from the type of power source indicated on the label. If you are not sure of the type of power supplied to your home, consult your dealer or local power company.
16. Class I Protective Earthing Connection – "The Class I apparatus shall be connected to a mains socket outlet with a protective earthing connection."
17. Disconnect Device - Mains Plug or Appliance Coupler – "The mains plug or appliance coupler is used as the disconnect device, the disconnect device shall remain readily operable."
18. Disconnect Device - An all-pole MAINS SWITCH – "An all-pole MAINS SWITCH is used as the disconnect device, the switch shall remain readily operable."
19. Service Instructions – "CAUTION – These servicing instructions are for use by qualified service personnel only. To reduce the risk of electric shock, do not perform any servicing other than that contained in the operating instructions unless you are qualified to do so."
20. Wall Mount Bracket Wording – "For use only with UL Listed Wall Mount Bracket with minimum weight/load: Please see page.24"
21. Information about the DTV transition –after June 12,2009, a television receiver with only an analog broadcast tuner will require a converter box to receive full power over-the- air broadcasts with an antenna because of the Nation's transition to digital broadcasting. Analog-only TVs should continue to work as before to receiver low power, Class A or translator television stations and with cable and satellite TV services, gaming consoles, VCRs, DVD players, and similar products. For more information about the DTV transition is available from <http://www.DTV.gov> or 1-888-CALL-FCC, and from <http://www.dtv2009.cov> or 1-888-DTV-2009 for information about subsidized coupons

for digital-to-analog converter boxes.

**CONSUMER ALERT** – This television receiver has only an analog broadcast tuner and will require a converter box after June 12, 2009, to receive over-the-air broadcasts with an antenna because of the Nation's transition to digital broadcasting. Analog-only TVs should continue to work as before with cable and satellite TV services, gaming consoles, VCRs, DVD players, and similar products. For more information, call the Federal Communications Commission at 1-888-225-5322 (TTY: 1-888-835-5322) or visit the Commission's digital television website at: [www.DTV.gov](http://www.DTV.gov).

22. **Tilt/Stability** – All televisions must comply with recommended international global safety standards for tilt and stability properties of its cabinets design.
  - Do not compromise these design standards by applying excessive pull force to the front, or top, of the cabinet, which could ultimately overturn the product
  - Also, do not endanger yourself, or children, by placing electronic equipment/toys on the top of the cabinet. Such items could unsuspectingly fall from the top of the set and cause product damage and/or personal injury.
23. **Wall or Ceiling Mounting** – The appliance should be mounted to a wall or ceiling only as recommended by the manufacturer.
24. **Power Lines** – An outdoor antenna should be located away from power lines.
25. **Outdoor Antenna Grounding** – If an outside antenna is connected to the receiver, be sure the antenna system is grounded so as to provide some protection against voltage surges and built up static charges. Section 810 of the National Electric Code, ANSI/NFPA No. 70-1984, provides information with respect to proper grounding of the mats and supporting structure grounding of the lead-in wire to an antenna-discharge unit, size of grounding connectors, location of antenna discharge unit, connection to grounding electrodes and requirements for the grounding electrode. See Figure below.

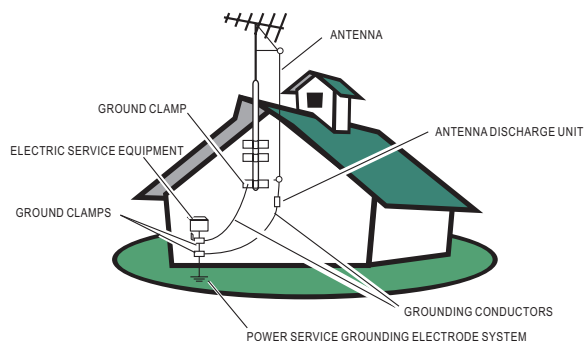

**EXAMPLE OF ANTENNA GROUNDING AS PER NATIONAL ELECTRICAL CODE** Note to the CATV system installer: This reminder is provided to call the CATV system installer's attention to Article 820-40 of the NEC that provides guidelines for proper grounding and, in particular, specifies that the cable ground shall be connected to the 6 English grounding system of the building, as close to the point of cable entry as practical. Please, make sure to connect the power plug to the wall outlet socket after connecting the TV to the adapter!

26. Apparatus shall not be exposed to dripping or splashing and no objects filled with liquids, such as vases, shall be placed on the apparatus.



## PREPARATION

**IMPORTANT:** Do not apply pressure to the screen display area which may compromise the integrity of the display. The manufacturer's warranty does not cover user abuse or improper installations.

### ATTACHING THE BASE

**IMPORTANT:** The Base of the HDTV must be assembled prior to usage.

1. Place TV unit face down on a soft and flat surface (blanket, foam, cloth, etc.) to prevent any damage to the HDTV.
2. Carefully align and insert the Base to the stand.
3. Insert the screws to the bottom of the base and tighten the base to the stand.

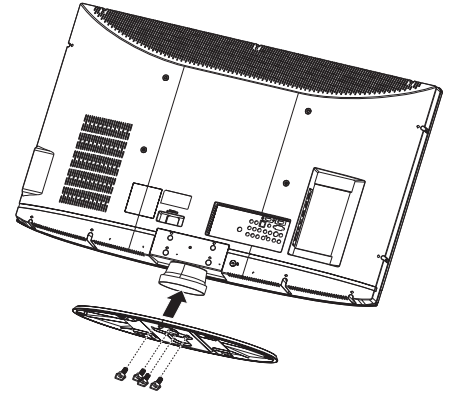

### PREPARING YOUR LCD HDTV FOR WALL MOUNTING

We suggest that you keep your TV at least 2.56 inches (65 mm) from the wall to prevent cable interference.

Before mounting your TV on the wall, you need to remove the base.

For your safety, please use only with UL listed wall mount bracket with minimum weight of the TV without stand. (Please see page.16.)

To attach a wall mount bracket to your TV:

- 1 Loosen the screws on the back of the stand and remove the back cover of the stand.
- 2 Pull up the stand base from the hinge to remove the stand base from your TV.
- 3 Secure the wall mount bracket to the back of your TV using four M6 screws, as indicated in the illustration.

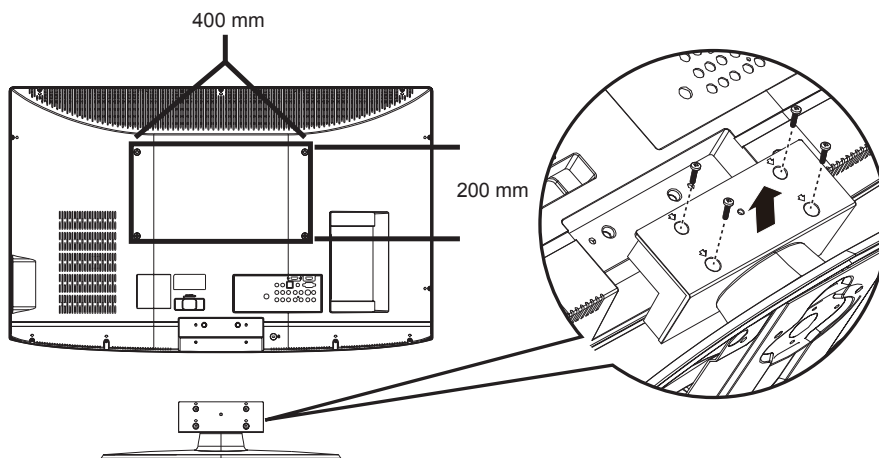

#### NOTE

- ▶ 400mmx200mm wall mount bracket & M6 screws are not included.
- ▶ After taking the base apart, users must attach the two screw lockers (marked the picture) to machine, in order to prevent gap after hanging on the wall.

Please make sure to connect the power plug to the wall outlet socket after connecting the TV to the power cord!

**1. Install the base stand; place the TV on a solid surface.**

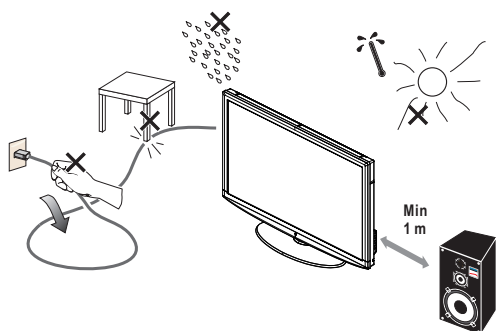

Ensure that the TV is placed in a position to allow free flow of air. Do not cover the ventilation openings on the back cover. To prevent any unsafe situations, no naked flame sources, such as lighted candles, should be placed on or in the vicinity. Avoid heat, direct sunlight and exposure to rain or water. The equipment shall not be exposed to dripping or splashing.

**2. Connect the antenna cable or CATV cable to the aerial socket ANT IN 75Ω at the back of the TV set.**

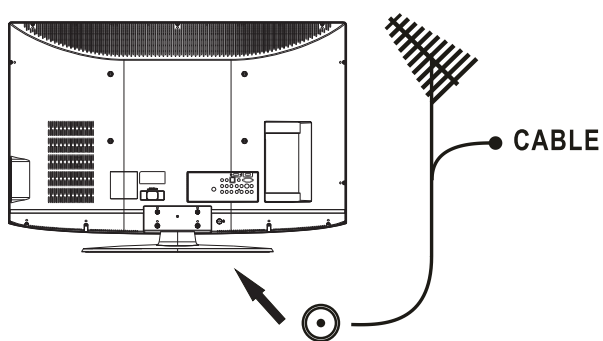

**3. Remote control:**

Remove the cover of the battery compartment. Insert the 2 batteries supplied (Type AAA 1.5V).

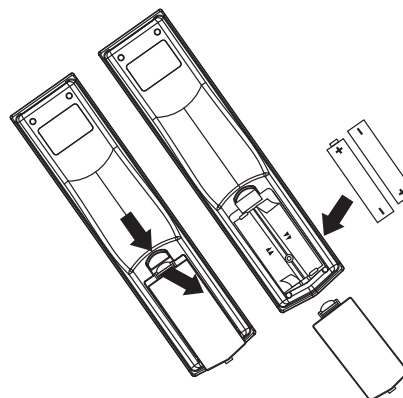

**4. Power:**

Insert the power cord in the wall socket with AC power supply. You can see LED states at the front panel. If the LED color is Blue, means the TV set is power on. If the LED color is Red, which means this TV set is in standby state.

**5. Turn the TV on:**

Press the POWER key on the Remote control or the side panel control knobs. The TV will be turned on in a minute with display on the screen.

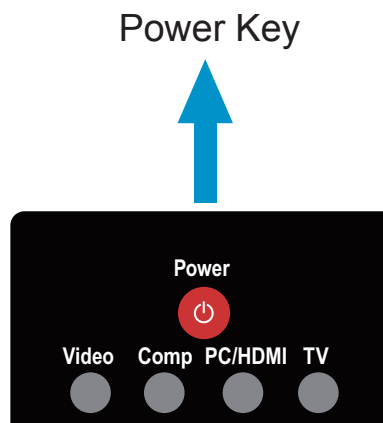

# PERIPHERAL CONNECTION GUIDE

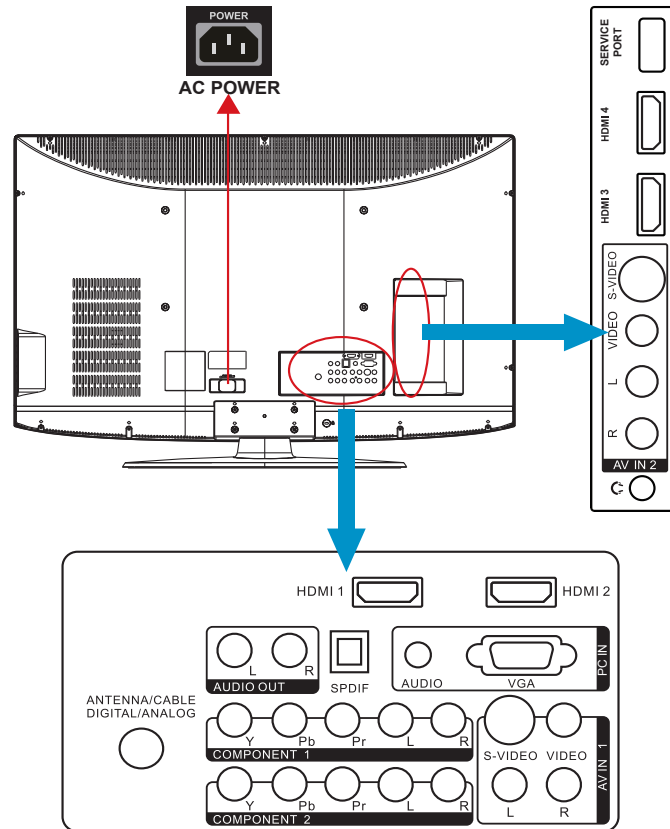

1. **HDMI** – Connect the primary source for digital video such as a DVD multimedia player or set top box through this all digital connector. The white color band on the rear of the TV indicates this connection.
2. **PC IN** – Connect the video and audio cables from a computer here.
3. **AV IN (AV/S-VIDEO)** – Connect the input source for composite video devices, such as a VCR or video game. Use the white and red connectors to connect the external audio from the same source. The signal being carried by the S-Video cable and connector, if connected, will take priority over the Video RCA connector (yellow connector).
4. **COMPONENT (Y/Pb/Pr with Audio L/R)** – Connect the primary source for component video devices such as a DVD Player or set top box here. From left to right, use red for Pr, blue for Pb, green for Y, red for right audio (R) and white for left audio (L) inputs.
5. **ANTENNA/CABLE DIGITAL/ANALOG** – Connect to an antenna or digital cable (out-of-the-wall, not from Cable Box) for Digital TV.\*
6. **SPDIF (Optical Digital Audio Out)** – When a digital audio signal is associated with the input selected for viewing, the digital audio will be available on this SPDIF connection to your home theater system.
7. **AUDIO OUT** – Connect an external sound system with standard audio cable to the AUDIO OUT L and R jacks on the back of your TV and to the AUDIO IN jacks on the amplifier.

Once your equipment is connected, use the following procedure to view the input signal:  
 Press the source button on the remote controller to select the relevant source to view. (ex: Press COMP button to select “Component” if you have connected a video recorder to Component socket.)

# OPERATING INSTRUCTIONS

## TO USE THE FRONT PANEL CONTROL

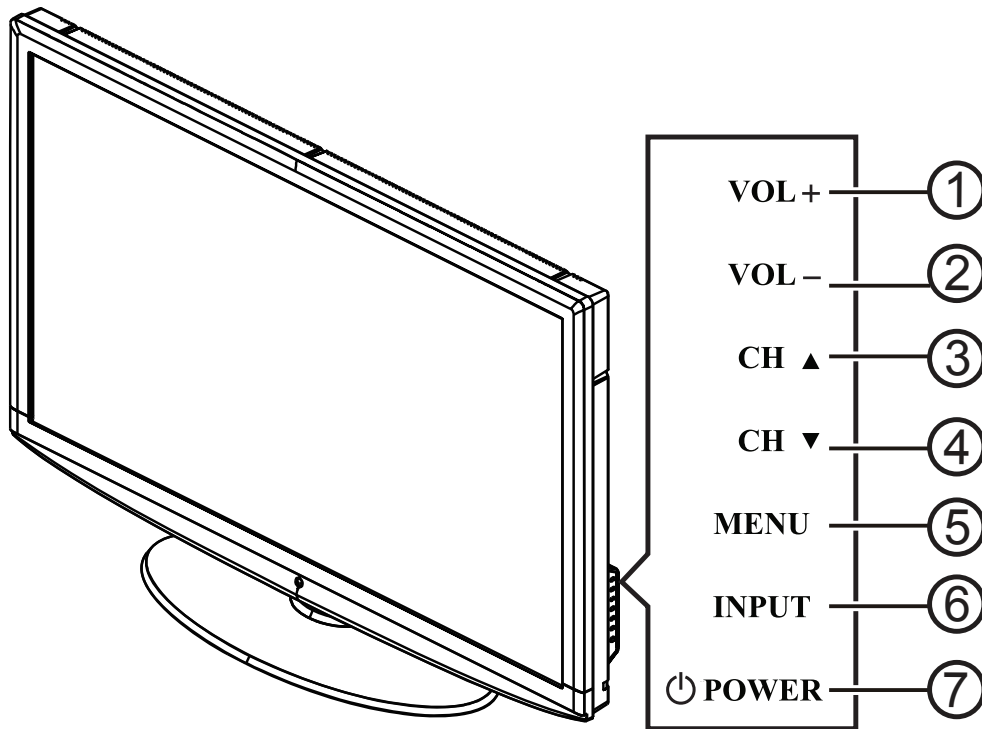

1	VOL +	<b>VOL +:</b> Press to increase the sound volume level.
2.	VOL -	<b>VOL - :</b> Press to decrease the sound volume level.
3.	CH ▲	<b>CH +:</b> Press to select the next higher Program number.
4.	CH ▼	<b>CH - :</b> Press to select the next lower Program number.
5.	MENU	<b>Menu key:</b> Press to open or exit the OSD (on-screen display) menu.
6.	INPUT	<b>Source key:</b> Press to select the input source.
7.	⏻ POWER	<b>Power key:</b> Press to turn on / off (standby) the TV set. (Press to turn on TV after the power on status, LED had changed to the Blue color and stopped flashing.)

## TO USE THE REMOTE CONTROL

### POWER

Press to power ON/OFF (standby) TV. (Note: 1. TV is never completely power off, unless physically unplugged. 2. Press to turn on TV after the power on status, LED had changed to the blue color and stopped flashing.)

### VIDEO

Press repeatedly to choose AV1/AV2 source mode.

### COMP

Press repeatedly to choose Component 1/Component 2 source mode.

### PC/HDMI

Press repeatedly to choose VGA or HDMI source mode (HDMI1, 2, 3, 4).

### TV

Press to choose ATSC/NTSC TV source mode.

### 0 ~ 9 /- number

Press to enter TV channel number to select channel (Press '-' to choose the sub-channel).

### SLEEP

Press to set a time period (off/5 min /10 min /15 min /30min/45 min /60min/90min/120 min /180 min /240 min) after which the TV should switch itself to standby mode.

### FREEZE

Press to freeze the displayed picture.

### CH-/ CH +

Press + or - to browse through the TV channels.

### MENU

Press to open or exit menu.

"<",">","^","v","ENTER

Press to adjust the various function items on the menu.

### PREV CH

Press to display the previous channel

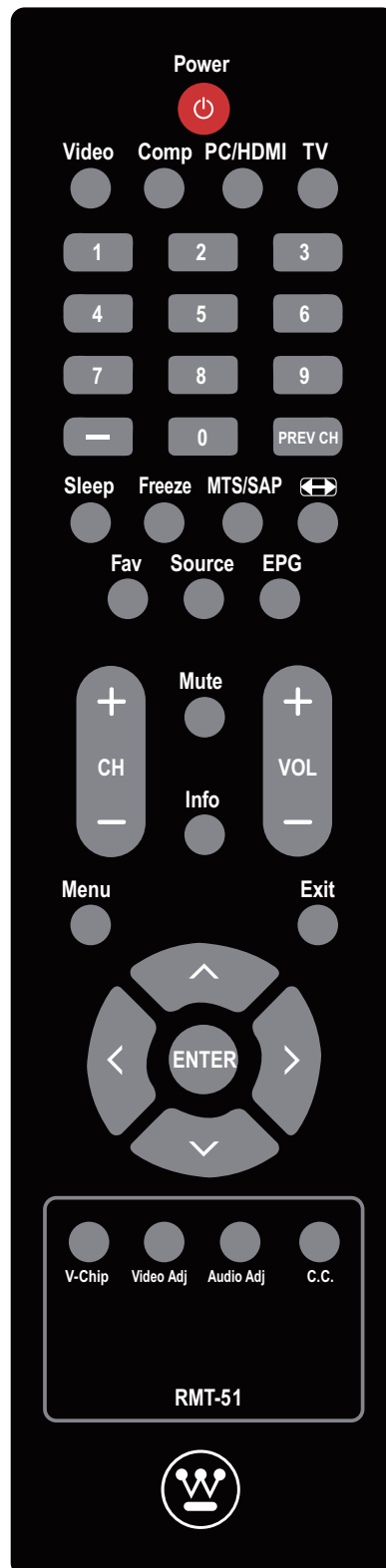

### MTS/SAP

Press to activate the NTSC TV sounds, such as: Stereo, SAP or Mono tone, and languages ofDTV.



Press to choose the display aspect as: Normal, Wide, Zoom or Cinema mode.

### SOURCE

Press repeatedly to choose the various input sources (Video 1 ~ 6).

### EPG

This function is not supported.

### MUTE

Switch the sound ON/OFF

### DISPLAY

Press to show the information about the input source, TV channel, display resolution and current time.

### VOL- /VOL+

Press + or - to adjust the volume.

### EXIT

Press to exit menu or OSD.

### V-CHIP

Press to lock / unlock Parental Control temporarily. (After setting the restricted table of MPAA or TV Rating.)

### VIDEO ADJ

Press to choose the Vivid/ Standard/PWR/Theater/Sport/ Custom.

### AUDIO ADJ

Press to choose Standard/Movie/ News/Custom.

### CC

Press repeatedly to change the closed caption type as CC ON/CC OFF/CC ON WHEN MUTE.

### FAVORITE

Press to toggle the Favorite/ Normal mode.

## TO USE THE MENUS

1. Press the **MENU/EXIT** button to display or close the main menu
2. Use the **Navigation Ring** to move around to select, adjust or confirm an item in the OSD (On Screen Display) menu.

Press the **MENU/EXIT** button to enter the main OSD. Adjust the items including **Video menu, Audio menu, Feature menu, Channel menu** and **VGA menu**. However, some function items in the menus may only be enabled in the particular source modes.

## CHANNEL MENU

The Channel menu in TV mode shows as below.

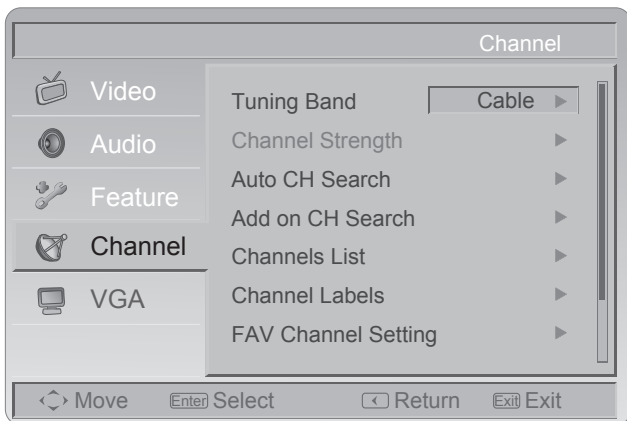

1. **Tuning Band:** Select TV source signal from the Air (antenna) or Cable (CATV).
2. **Channel Strength:** Show the intensity of the received DTV signal.
3. **Auto CH Search:** Automatically scan all NTSC / ATSC TV channels and then store in the channel table. In channel scan process, the OSD can display the number of channels which had been found.
4. **Add on CH search:** Add channels which are new found.
5. **Channels List:** Show the channel List. User can edit (add/delete) the channel numbers.
6. **Channel Labels:** Show the NTSC / ATSC TV channel label menu for user modifying channel labels specifically.

7. **FAV Channel Setting:** Show the Favorite Channel List. User can edit (add/delete) the favorite channels.

## VIDEO MENU

The Video menu in most source modes shows as below. It provides several video adjustment items for user fine tuning the video display. Only in VGA source mode, the Video menu simply provides **Brightness, Contrast, Backlight, Color Temp, Aspect Ratio** and **Preset** items.

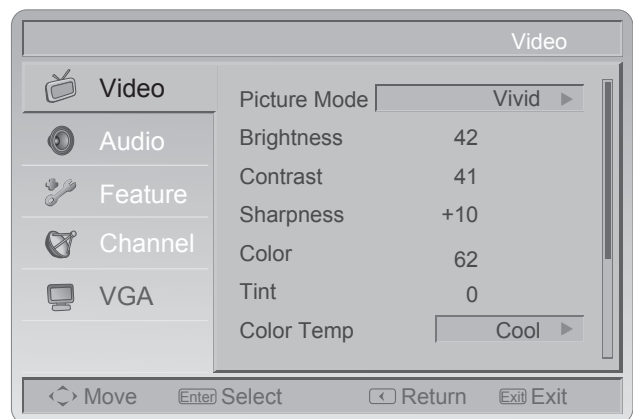

1. **Picture Mode:** Adjust the best picture appearance from selecting the preset value of Vivid, Standard, PWR, Theater, Sport, or Custom.
2. **Brightness:** Video brightness adjustment, the tuning range is 0 ~ 100.
3. **Contrast:** Video contrast adjustment, the tuning range is 0 ~ 100.
4. **Sharpness:** Video sharpness adjustment, the tuning range is 0 ~ 100.
5. **Color:** Video color chroma adjustment, the tuning range is 0 ~ 100.
6. **Tint:** Video tint adjustment, the tuning range is R50 ~ G50.
7. **Color Temp:** Three color temperature modes. (Normal / Warm / Cool)
8. **Backlight:** Backlight strength adjustment, the tuning range is 0 ~ 30.
9. **Aspect Ratio:** Choose the display aspect: Standard/Fill/Overscan.
10. **Preset:** Restore the default video settings.

## AUDIO MENU

The Audio menu in TV mode shows as below. It provides audio adjustment for user to modify the audio setting. Audio language setting is only available with ATSC TV source, the option is disable under other source modes.

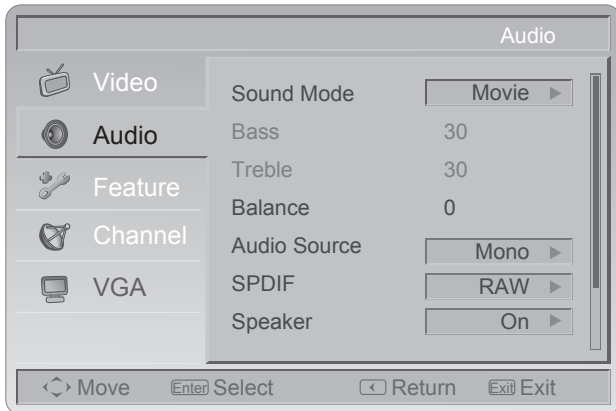

1. **Sound Mode:** Choose the sound mode: Standard, Movie, News, or Custom.
2. **Bass:** Bass tone adjustment, the tuning range is 0 ~ 63. (The default state is enabled)
3. **Treble:** Treble tone adjustment, the tuning range is 0 ~ 63. (The default state is enabled)
4. **Balance:** Audio balance adjustment, the tuning range is L50 ~ R50.
5. **Audio Source:** Select the audio source from Mono, Stereo, or SAP. (This function works in ATV only).
6. **Audio Language:** Change the audio language setting on ATSC TV programs. The number of the supported audio languages depends on the ATSC TV programs. (English / Français / Español)
7. **SPDIF:** Digital audio output format. Select from RAW and PCM.
8. **Speaker:** Choose to turn on / off the TV internal speaker. The digital audio output signals and earphone output signals will not be turned off even though the TV speaker is off. The default setting is On.
9. **AVL:** Choose On or off to adjust volume to be consistent across programs and channels automatically.

10. **Preset:** Restore the default audio settings.

## FEATURE MENU

The Feature menu in TV mode shows as below. This menu gives users the most flexibilities to satisfy their generally demands. According to the various requirements in different source modes, certain features should be hidden (disable) on the menu. The details footnotes will be described clearly below.

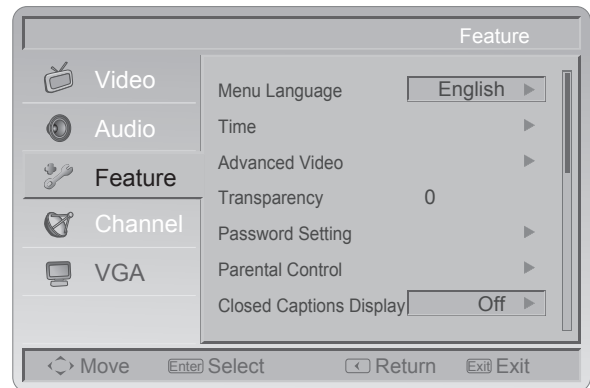

1. **Menu Language:** Select the menu display language. (English / Français / Español)
2. **Time:** Set current time. The sub-menu includes Time Mode, Time Zone and Daylight Savings.

**[Time Mode]** – Choose from Auto or Manual.

**[Time Zone]** – Set current time zone.

**[Daylight Savings]** – Set to On or Off.

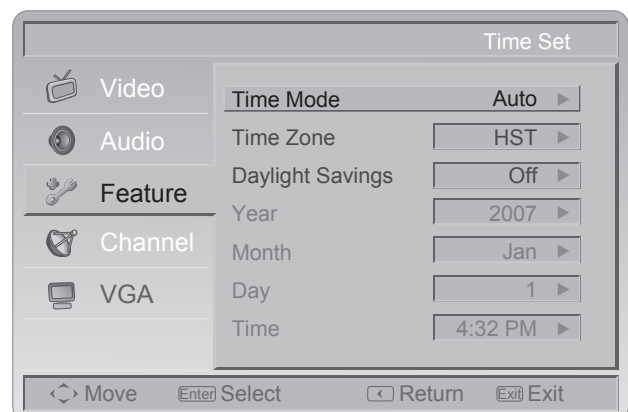

3. **Advanced Video:** Provide the Noise Reduction, Adaptive Contrast, and DCR for enhancing video quality.

**[Noise Reduction]** – Gives four NR effect degrees, such as: Low, Mid, High and Off. The default setting is Mid.

**[Adaptive Contrast]** – Choose On or off to adjust the gamma after analyzing the input signal automatically.

**[DCR]** – Dynamic Contrast Ratio (DCR) auto adjusts the backlight of the screen.

**[SMP]** – SMP means "Smart Motion Plus", gives four motion effect degrees, such as: Low, Mid, High and Off. The default setting is Mid.

**[Preset]** – Restore the default advanced video option settings.

4. **Transparency:** Adjust the transparency of the on-screen menu from range 1 to 10.
5. **Password Set:** Change the 4-numeral parental control password. Three steps are required for changing the password: Enter Old Password -> Enter New Password -> Confirm New Password. Note: This item is only available in TV, Composite and S-Video source modes. The default password is 『 0 0 0 0 』 .

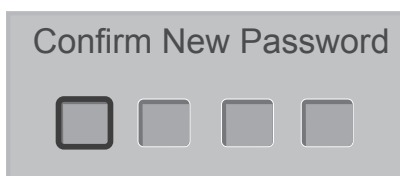
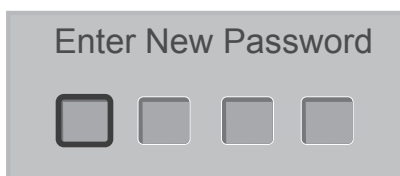
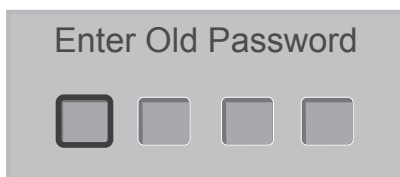

6. **Parental Control:** provide the parental Control (V-chip) function setting. Before entering the Parental Control sub-menu, user has to key in the password first. Enter the Parental Lock item, then the user can modify the restricted table about MPAA or TV Rating respectively. While exiting the sub-menu, the parental control function is working. The inhibitive channels or source

signals can be un-lock through pressing the V-CHIP key on the remote control and then key in the correct password. Note: This feature is only available in TV, Composite and S-Video source modes. (The default password is: 0 0 0 0.)

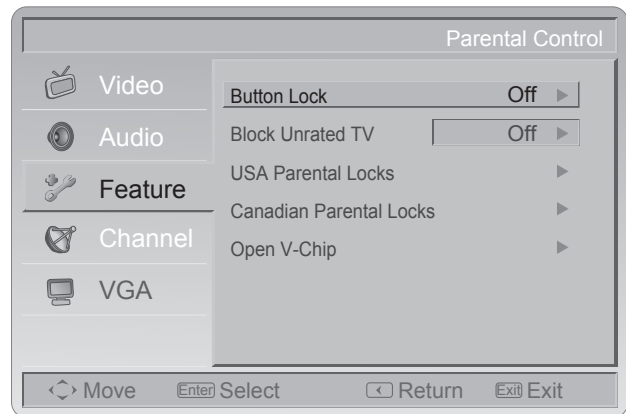
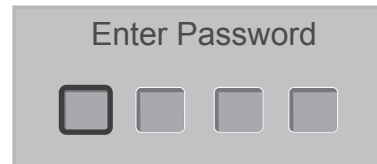

**[Button Lock]** – Select On or Off to lock or unlock the control buttons on the side panel of the TV. When this function enables, the control buttons on your TV will be locked and TV will be controlled by remote control only.

**[Block Unrated TV]** – When Block Unrated TV is set to on, your TV will block unrated program.

**[USA Parental Locks]** – Set the parental control level by MPAA or TV Rating.

**[Canadian Parental Locks]** – Set the parental control level by English Rating or French Rating.

**[Open V-Chip]** – Open V-Chip is an advanced V-Chip rating system for digital channels that are received.

The rating table will be updated by downloading the RRT5 data for blocking.

7. **Closed Captions Display:** Select a closed caption options. (Off / On / On With Mute)
8. **Analog Captions:** Select an analog caption options. (CC 1-4 / TEXT 1-4)



9. **Digital Captions:** Select a digital caption options. (Service 1-6)

10. **Digital Captions Setup:** Provide numerous options for setting the digital closed caption style in the sub-menu.

**[Style]** – Set to Automatic or Custom mode. If Custom mode is selected, user can modify the detail styles described below. The setting result will be shown immediately on the bottom of the sub-menu OSD. Note: This feature is only available in Digital TV (ATSC) mode.

**[Size]** – Digital closed caption font size, which can be set as Automatic, Small, Normal or Large.

**[Font]** – Digital closed caption font style, which can be chosen as Automatic, Default or Font 1 ~ 7.

**[Text Color]** – Automatic / White / Red / Green / Blue / Yellow / Magenta / Cyan / Black

**[Text Opacity]** – Automatic / Solid / Flashing / Transparent / Translucent

**[Background Color]** – Automatic / Black / White / Red / Green / Blue / Yellow / Magenta / Cyan

**[Background Opacity]** – Automatic / Solid / Flashing / Transparent / Translucent

**[Edge Effect]** – Automatic / None / Raised / Depressed / Uniform / Left Shadow / Right Shadow

**[Edge Color]** – Automatic / Red / Green / Blue / Yellow / Magenta / Cyan / Black / White.

11. **Input Labels:** User can edit the input labels.

12. **Component Setting:** This option only shows and is available in component mode, which provides fine tuning component display.

**[Phase]** – Adjust Picture Phase to reduce Horizontal-Line noise. The tuning range is from 0 to 100.

**[Preset]** – Restore the default component setting values.

13. **Reset to Default:** Restore all the default settings.

## VGA MENU

This option only shows and is available in VGA mode, which provides several items for the VGA display fine tuning.

1. **H-Position:** Adjust the horizontal position of the picture. (0-100)

2. **V-Position:** Adjust the vertical position of the picture. (0-100)

3. **Clock:** Adjust picture clock to reduce Vertical-Line noise. (0-100)

4. **Phase:** Adjust Picture Phase to reduce Horizontal-Line noise. (0-100)

5. **Auto Adjust:** Adjust the settings automatically.

6. **Preset:** Restore the default VGA setting values.

## TIPS

### Care of the screen

Do not rub or strike the screen with anything hard as this may scratch, mar, or damage the screen permanently.

Unplug the power cord before cleaning the screen. Dust the TV by wiping the screen and the cabinet with a soft, clean cloth. If the screen requires additional cleaning, use a clean, damp cloth. Do not use liquid cleaners or aerosol cleaners.

### Mobile telephone warning

To avoid disturbances in picture and sound, malfunctioning of your TV or even damage to the TV, keep away your mobile telephone from the TV.

### End of life directives

We are paying a lot of attention to produce environmental friendly in green focal areas. Your new receiver contains materials, which can be recycled and reused.

At the end of its life, specialized companies can dismantle the discarded receiver to concentrate the reusable materials and to minimize the amount of materials to be disposed of.

Please ensure you dispose of your old receiver according to local regulations.

### Dolby License Notice and Trademark Acknowledgement



Manufactured under license from Dolby Laboratories.

"Dolby" and the double-D symbol are trademarks of Dolby Laboratories

## Regulatory Notices – Federal Communications Commission Notice

This equipment has been tested and found to comply with the limits for a Class B digital device, pursuant to part 15 of the FCC Rules. These limits are designed to provide reasonable protection against harmful interference in a residential installation. This equipment generates, uses, and can radiate radio frequency energy and, if not installed and used in accordance with the instructions, may cause harmful interference to radio communications. However, there is no guarantee that interference will not occur in a particular installation. If this equipment does cause harmful interference to radio or television reception, which can be determined by turning the equipment off and on, the user is encouraged to try to correct the interference by one or more of the following measures:

- Reorient or relocate the receiving antenna.
- Increase the separation between the equipment and the TV.
- Connect the equipment into wall power outlet on a circuit different from that to which the receiver is connected.
- Consult the dealer or an experienced radio or television technician for help.

### Modifications –

The FCC requires the user to be notified that any changes or modifications made to this device that are not expressly approved by our company may void the user's authority to operate the equipment.

### Cables –

Connections to this device must be made with shielded cables with metallic RF/EMI connector hoods to maintain compliance with FCC Rules and Regulations.

### Canadian notice –

This Class B digital apparatus meets all requirements of the Canadian Interference-Causing Equipment Regulations.

### Avis Canadian –

Cat apparel numerous de la classed B respecté toutes les exigences du règlement sur le matériel brouilleur du Canada.

# PRODUCT SPECIFICATION

---

## NOTE

- \* This model complies with the specifications listed below.
- \* Designs and specifications are subject to change without notice.
- \* This model may not be compatible with features and/or specifications that may be added in the future.
- \* 42" LCD TV (42" viewable) Viewable image size: 1067mm diagonal

## Television System:

NTSC standard  
ATSC standard (8-VSB, Clear-QAM)

## Channel Coverage:

VHF: 2 through 13  
UHF: 14 through 69  
Cable TV: Mild band (A - 8 through A - 1, A through I ) Super band (J through W) Hyper band (AA through ZZ, AAA, BBB) Ultra band (65 through 94, 100 through 125)

## Power Source:

AC power supply: 100V~240V, 50/60 Hz

## Power Consumption

≤ 250 W  
1 W in standby mode (power cord plugged in and power OFF)

## Audio Power

10 W + 10 W, Internal Speaker

## Video/Audio Terminals:

Rear AV x1: S-Video/Video/Audio Input  
Side AV x1: S-Video/Video/Audio Input

## S-VIDEO INPUT:

Y: 1 V(p-p), 75 ohm, negative sync.  
C: 0.286 V(p-p) (burst signal), 75 ohm

## VIDEO/AUDIO INPUT:

VIDEO: 1 V(p-p), 75 ohm, negative sync.  
AUDIO: 300mv(rms)

## Component INPUT:

Rear Component x2:  
Y: 1V(p-p), 75 ohm, including sync.  
Pr/Cr: ±0.35V(p-p), 75 ohm  
Pb/Cb: ±0.35V(p-p), 75 ohm  
AUDIO: 300mv(rms)  
Supported resolutions: 1080p, 1080i, 720p, 480p, 480i

## HDMI Terminals:

HDMI INPUT: Rear HDMI x2; Side HDMI x2  
HDCP compliant  
E-EDID compliant  
Supported scan rates: 1080p, 1080i, 720p, 480p, 480i

## VGA Terminals:

VGA INPUT:  
Rear VGA (D-SUB 15 Pin) Input x1  
E-EDID compliant  
Supported scan rates:  
640X480 /60Hz  
800x600/60Hz  
1024X768 /60Hz  
1680X1050 /60Hz  
Recommended: 1920X1080 /60Hz  
Audio INPUT: Headphone Mini-jack for stereo (3.5Ø )  
Audio Out: SPDIF / RCA Jack (R/L)

## Environmental Temperature: 5°C - 35°C

## Dimensions:

Include Stand:  
1009.5mm(W) x 688.0mm(H) x 262.2mm(L)

## Weight:

19.8kg (With Stand)  
17.8kg (w/o stand and base)

## Wall Mounting:

400 x 200mm  
(Wall mount kit is not included)

## Supplied Accessories:

1pcs Power cord  
1pcs Remote control  
(with two size AAA alkaline batteries)  
1pcs User manual  
1pcs Setup Guide

## BEFORE CALLING SERVICE

---

Please make these simple checks before calling service. These tips may save you time and money since charges for receiver installation and adjustments of customer controls are not covered under your warranty.

Symptoms	Items to Check and Actions to follow
“Ghost ” or double image	*This may be caused by obstruction to the antenna due to high rise buildings or hills. Using a highly directional antenna may improve the picture.
No power	*Check if the TV’s AC power cord is plugged into the mains socket. *Unplug the TV, wait for 60 seconds. Then reinsert plug into the mains socket and turn on the TV again.
No picture	*Check antenna connections at the rear of the TV to see if it is properly connected to the TV. *Possible broadcast station trouble. Try another channel. *Adjust the contrast and brightness settings. *Check the Closed Captions control. Some TEXT modes could block the screen.
Good picture but no sound	*Increase the VOLUME. *Check if the TV is muted; press the MUTE button on the remote control.
Good sound but poor color	*Adjust the contrast, color and brightness settings.
Poor picture	*Poor picture quality may occur when an activated S-VHS camera or camcorder is connected to your TV and the other peripheral at the same time. Switch off one of the peripherals.
Snowy picture and noise	*Check the antenna connection.
Horizontal dotted line	*This may be caused by electrical interference (e.g. hairdryer, nearby neon lights, etc.) *Turn off the equipment.
Television not responding to remote control	*Check whether the batteries are working. Replace if necessary. *Clean the remote control sensor lens on the TV. *You can still use the buttons at the front of your TV. *Select the TV mode to ensure your remote control is set in the TV mode.

## **GLOSSARY**

### **HDTV**

HDTV displays are technically defined as being capable of displaying a minimum of 720p or 1080i active scan lines.

### **HDMI Inputs**

High-Definition Multimedia Interface

### **Audio / Video Inputs**

Located on the rear of the receiver, these connectors (RCA phono type plug) are used for the input of audio and video signals. Designed for use with VCRs (or other accessories) in order to receive higher picture resolution and offer sound connection options.

### **Menu**

An on-screen listing of features shown on the TV screen is made available for user adjustments.

### **MPAA**

Motion Picture Association of America

### **Multichannel Television sound (MTS)**

The broadcasting standard, which allows stereo sounds to be transmitted with the TV picture.

### **RF**

Radio Frequency or modulated signal design used as the carrier for television broadcasts.

### **Second Audio Program (SAP)**

Another or additional audio channel provided for in the Multichannel Television Sound (MTS) broadcast standard. A monaural soundtrack included within the recorded or video signal (usually containing a second language translation for the displayed program).

### **Sleep Timer**

You can set a time period for which the TV will be turn off automatically.

### **S-Video Input**

You can connect your TV set to a high-resolution video source (such as Super VHS video-cassette recorder, Laser Disc player and DVD Home Theater Set) in order to provide maximum consumer viewing satisfaction.

